

MCF SERIES

LINE SEIKI

SMALL ELECTRIC COUNTER • ECONOMY TYPE

DESCRIPTION

Economical electric totalizer with Pushbutton reset.
 Bail, rear or base mount.
 Compact for limited space installations.
 Applications: Amusement Equipment,
 Machine Tools, Measuring Devices,
 Office Machines, Test Instruments, etc.

MODELS

TYPE	MODELS	DIGITS	MOUNTING	WEIGHT
Additive Total Counter	MCF - 4X	4	Panel (Clip)	100 grams
	MCF - 6X	6		120 grams
Additive Total Counter	MCF - 4P	4	Panel (Screw)	100 grams
	MCF - 6P	6		120 grams

SPECIFICATIONS

Power Source	AC 100V,110V,200V,220V <50/60 Hz convertible> / DC 12V,24V
Voltage Fluctuation	-15 - +10%
Power Consumption	AC : 3 - 4VA ; DC : 2 - 3W
Continuous Energizing	permissible
Counting Method	One pulse - One count (energizing - 1/2 count, unenergized - 1/2 count)
Counting Speed	10 Hz (maximum)
Pulse Width	50msec. minimum
Make (Duty)	1 : 1
Display	4.0 - 2.4mm (white on black background)
Reset	Manual Reset (push button)
Connection	Lead Wire (250 mm)
Operating Temperature	-5°C - +40°C (non-freezing)
Operating Humidity	85%RH maximum (non-condensing)
Test Voltage	AC1,500V for 1 minute
Insulation Resistance	50MΩ minimum (500VDC megger)
Vibration	Endurance : 16.7 Hz, double amplitude 4mm / Malfunction : 10 - 55 Hz, double amplitude 0.5mm
Shock	Endurance : 30G / Malfunction : 5G
Construction	Cover : Plastic (gray)

DIMENSIONS

MCF - 4X

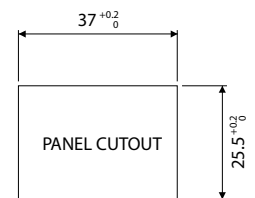
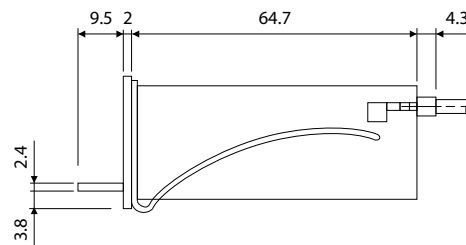
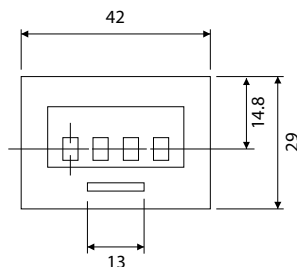

MCF - 6X

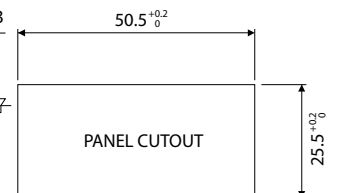
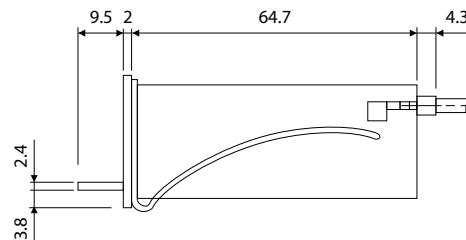
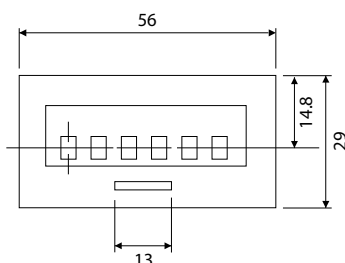

MCF - 4P

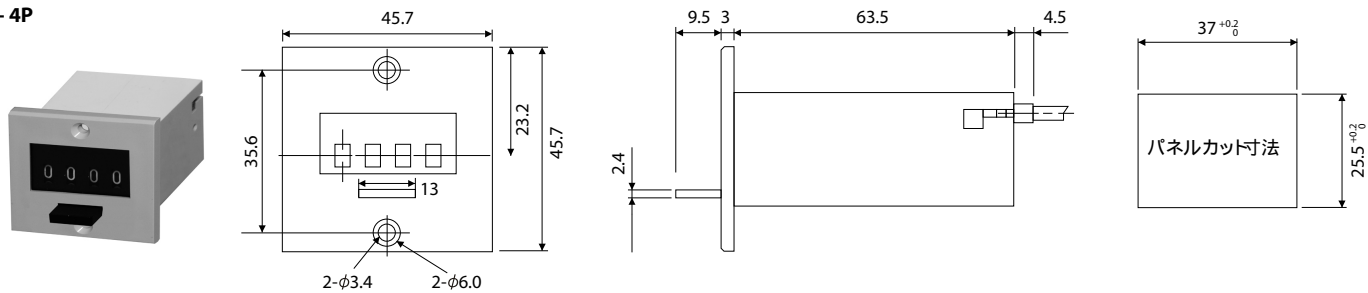

MCF - 6P

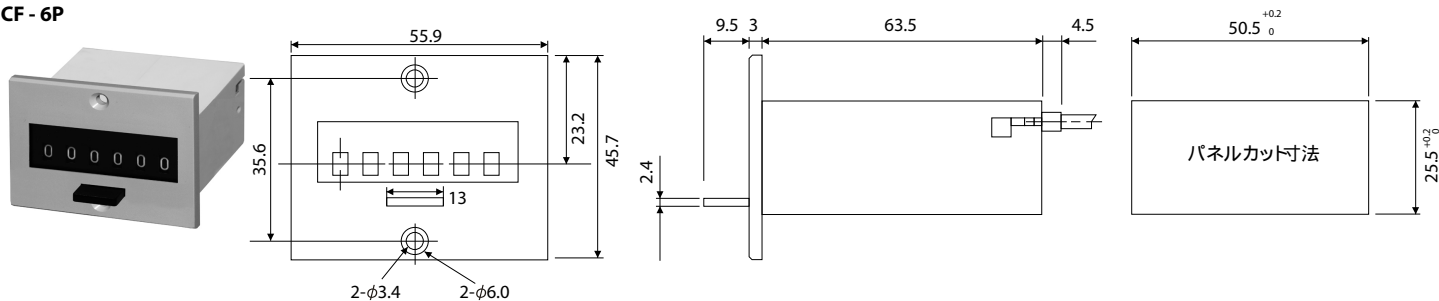

MOUNTING

X Type (Panel mount with clip)

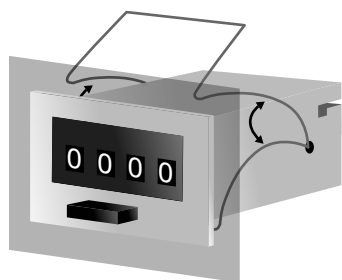

P Type (Panel mount with screw)

